

Product Summary

$V_R = 650\text{ V}$
 $I_F = 10\text{ A}$ ($T_C=150^\circ\text{C}$)
 $Q_C = 23\text{ nC}$ ($V_R=400\text{ V}$)

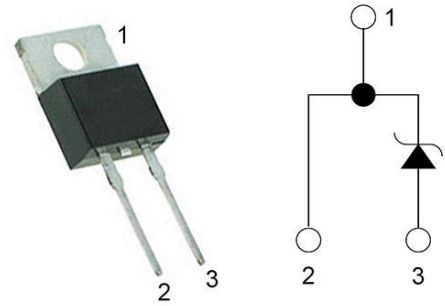

TO-220-2

Features

- Zero Forward/Reverse Recovery Current
- High Blocking Voltage
- High Frequency Operation
- Positive Temperature Coefficient on V_F
- Temperature Independent Switching Behavior

Benefits

- Higher System Efficiency
- Parallel Device Convenience without thermal runaway
- Higher Temperature Application
- No Switching loss
- Hard Switching & Higher Reliability
- Environmental Protection

Applications

- Motor Drives
- Solar
- AC/DC Converters
- DC/DC Converters
- Uninterruptable Power Supplies

Maximum Ratings ($T_C=25^\circ\text{C}$ unless otherwise specified)

Parameter	Symbol	Test conditions	Value	Unit
Peak Repetitive Reverse Voltage	V_{RRM}		650	V
Peak Reverse Surge Voltage	V_{RSM}		650	V
DC Blocking Voltage	V_R		650	V
Continuous Forward Current	I_F	$T_C=25^\circ\text{C}$ $T_C=135^\circ\text{C}$ $T_C=150^\circ\text{C}$	32 14 10	A
Non repetitive Forward Surge Current	I_{FSM}	$T_C = 25^\circ\text{C}$, $t_p=10\text{ ms}$, Half Sine Pulse $T_C = 150^\circ\text{C}$, $t_p=10\text{ ms}$, Half Sine Pulse $T_C = 25^\circ\text{C}$, $t_p=10\ \mu\text{s}$, Square	65 55 520	A
Repetitive peak Forward Surge Current	I_{FRM}	$T_C = 25^\circ\text{C}$, $t_p=10\text{ ms}$, Freq = 0.1Hz, 100 cycles, Half Sine Pulse $T_C = 150^\circ\text{C}$, $t_p=10\text{ ms}$, Freq = 0.1Hz, 100 cycles, Half Sine Pulse	55 45	A
Total power dissipation	P_D	$T_C=25^\circ\text{C}$	94	W
Operating Junction Temperature	T_J		-55 to 175	$^\circ\text{C}$
Storage Temperature	T_{STG}		-55 to 175	$^\circ\text{C}$

Stresses exceeding those listed in the Maximum Ratings table may damage the device. If any of these limits are exceeded, device functionality should not be assumed, damage may occur and reliability may be affected.

Electrical Characteristics

Parameter	Symbol	Test conditions	Min	Typ	Max	Unit
DC Blocking Voltage	V_{DC}	$I_R = 250\mu A, T_J = 25^\circ C$	650			V
Forward Voltage	V_F	$I_F = 10A, T_J = 25^\circ C$		1.45	1.8	V
		$I_F = 10A, T_J = 125^\circ C$		1.6		
		$I_F = 10A, T_J = 175^\circ C$		1.7		V
Reverse Current	I_R	$V_R = 650V, T_J = 25^\circ C$		12	80	μA
		$V_R = 650V, T_J = 125^\circ C$		68		μA
		$V_R = 650V, T_J = 175^\circ C$		190		μA
Total Capacitive Charge	Q_C	$V_R = 400V$ $T_J = 25^\circ C$		23		nC
Total Capacitance	C	$V_R = 1V, T_J = 25^\circ C,$ Freq = 1MHz		380		pF
		$V_R = 200V, T_J = 25^\circ C,$ Freq = 1MHz		48		
		$V_R = 400V, T_J = 25^\circ C,$ Freq = 1MHz		31		

Note: This is a majority carrier diode, so there is no reverse recovery charge

Thermal Characteristics

Parameter	Symbol	Condition	Min	Typ	Max	Unit
Thermal Resistance	$R_{th(j-c)}$	junction-case		1.6		$^\circ C/W$

Typical Electrical Curves

Figure 1. Forward Characteristics

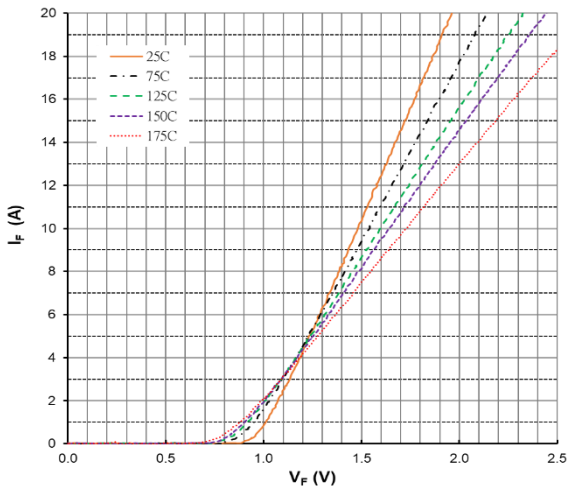

Figure 2. Forward Characteristics

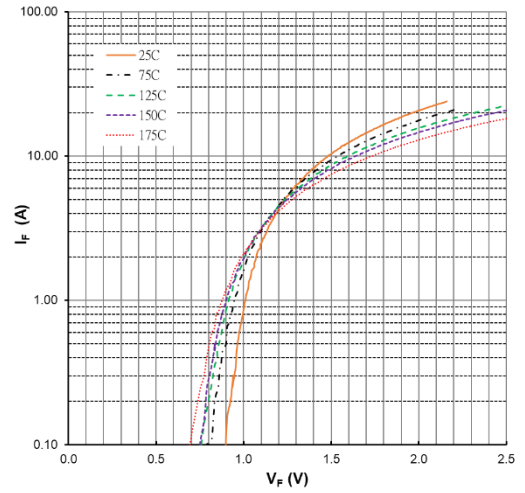

Figure 3. Reverse Characteristics

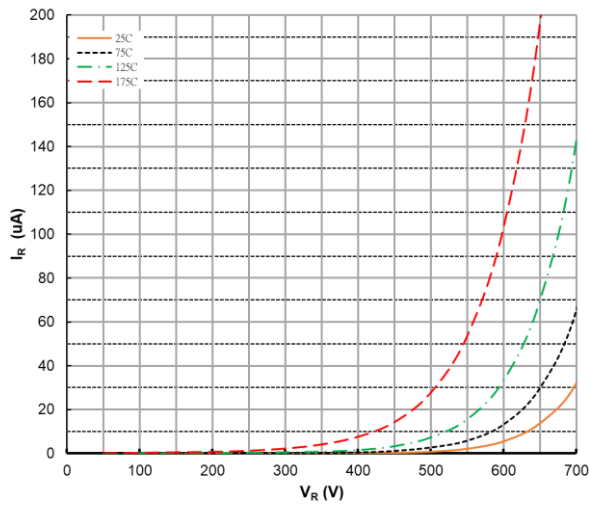

Figure 4. Power Derating

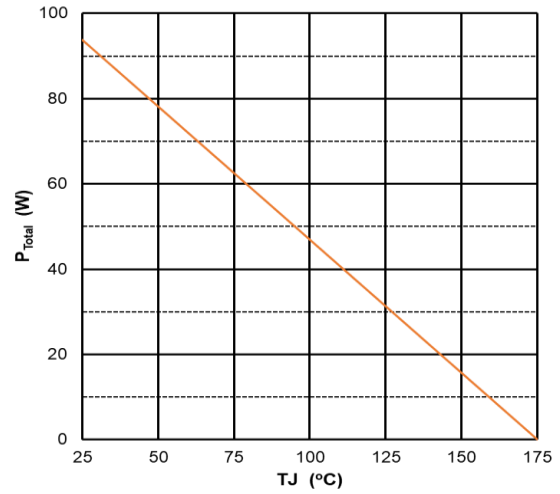

Figure 5. Capacitance vs Reverse Voltage

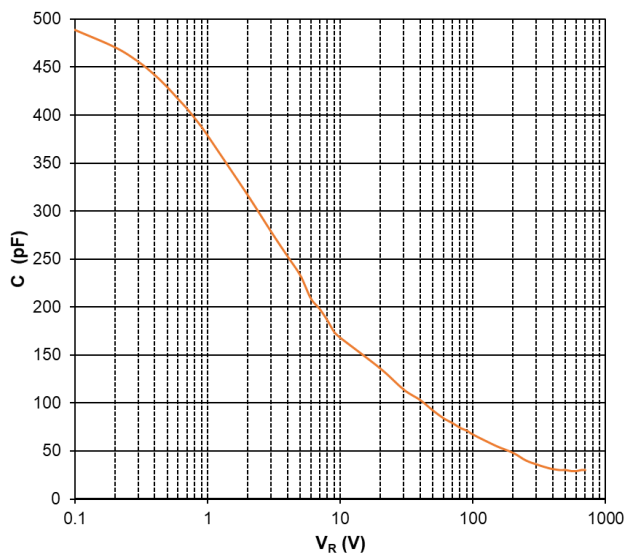
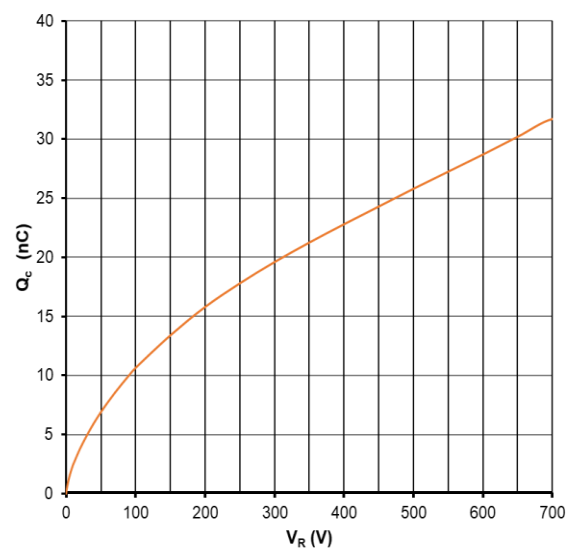
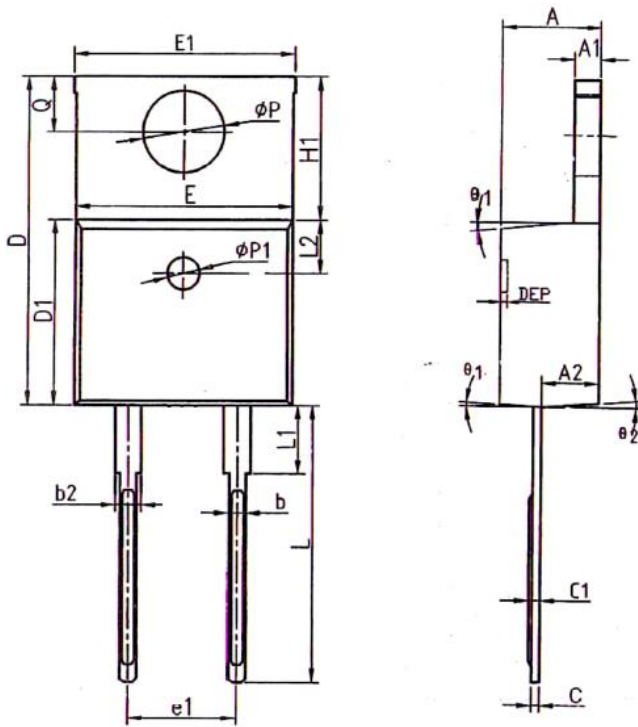

Figure 6. Recovery Charge vs Reverse Voltage



Package Dimensions

(TO-220-2 Package)



COMMON DIMENSIONS

SYMBOL	MM			INCH		
	MIN	NOM	MAX	MIN	NOM	MAX
A	4.40	4.57	4.70	0.173	0.180	0.185
A1	1.22	1.27	1.32	0.048	0.050	0.052
A2	2.59	2.69	2.79	0.102	0.106	0.110
b	0.77	0.813	0.90	0.030	0.032	0.035
b2	1.20	1.27	1.36	0.047	0.050	0.054
c	0.34	0.381	0.47	0.013	0.015	0.019
c1	0.40	0.559	0.60	0.016	0.022	0.024
D	14.70	15.00	15.30	0.579	0.591	0.602
D1	8.60	8.70	8.80	0.339	0.343	0.346
E	10.06	10.16	10.26	0.396	0.400	0.404
E1	10.10	10.25	10.35	0.398	0.404	0.407
E2	10.00	10.10	10.20	0.394	0.398	0.402
e	2.54 BSC			0.100 BSC		
e1	5.08 BSC			0.200 BSC		
H1	6.10	6.30	6.50	0.240	0.248	0.256
L	13.20	13.40	13.50	0.520	0.528	0.531
L1	-	3.75	4.00	-	0.148	0.157
L2	2.50 REF			0.098 REF		
ϕP	3.76	3.84	3.88	0.148	0.151	0.153
Q	2.60	2.743	2.90	0.102	0.108	0.114
$\theta 1$	5°	7°	9°	5°	7°	9°
$\theta 2$	1°	3°	5°	1°	3°	5°
$\phi P1$	1.40	1.50	1.60	0.055	0.059	0.063
DEP	0.05	0.10	0.20	0.002	0.004	0.008

Part Number	Package	Packing	Marking	M.O.Q
NF3D10065A	TO-220-2	50pcs / Tube	NF3D10065A	500